







REFERENCIA	TIPO	DESCRIPCION	L	A	OE	JUNTA
CASE / JCB						
CAS5005	SOLDAR	DEP.ENT/SUP:CASE:580/910/	730	125		
CAS5006	SOLDAR	DEP.SAL/INF:CASE:580/910/	730	125		
CATERPILLAR						
CAT9000	SOLDAR	DEP.ENT.LATON:CAT:MOD.VAR	587	105		
DAF						
DAF0001	GRAPAR	DEP.ENT/SUP:DAF: 75/85:	644	77	BEHR	60066
DAF0002	GRAPAR	DEP.SAL/INF:DAF: 75/85:	644	77	BEHR	60066
DAF0003	GRAPAR	DEP.ENT/SUP:DAF: 95 :	775	75	BEHR	60059
DAF0004	GRAPAR	DEP.SAL/INF:DAF: 95 :	775	75	BEHR	60059
DAF0005	GRAPAR	DEP. DAF F65/75 (MODINE)	644	77	MODINE	60066
DAF0006	GRAPAR	DEP. DAF F85 (MODINE)	644	77	MODINE	60066
DAF0007	GRAPAR	DEP.SUP. DAF LF45 (MODINE)	587	77	MODINE	60384
DAF0008	GRAPAR	DEP.INF. DAF LF45 (MODINE)	587	77	MODINE	60384
IVECO						
IVE0001	GRAPAR	DEP.SUP.STRALIS	773	72	BEHR	60059
IVE0002	GRAPAR	DEP.INF.STRALIS	773	72	BEHR	60059
IVE0003	GRAPAR	DEP.SUP.EUROTRAKER	773	72	BEHR	60059
IVE0004	GRAPAR	DEP.INF.EUROTRAKER	773	72	BEHR	60059
IVE0006	GRAPAR	DEP.SUP.EUROCARGO	635	59	BLACKSTONE	60143
IVE0007	GRAPAR	DEP.INF.EUROCARGO	635	59	BLACKSTONE	60143
IVE0008	GRAPAR	DEP.SUP.TECTOR	581	61	BEHR	60173
IVE0009	GRAPAR	DEP.INF.TECTOR	581	61	BEHR	60173
MAN						
MAN0001	GRAPAR	DEP.ENT MAN F2000	732	72	BEHR	60169
MAN0002	GRAPAR	DEP.SAL MAN F2000	732	72	BEHR	60169
MAN0003	GRAPAR	DEP.INF. MAN TG-A	961	72	BEHR	60214
MAN0004	GRAPAR	DEP.SUP.TG-L	645	77	L.R.	60066
MAN0005	GRAPAR	DEP.INF.TG-L	645	77	L.R.	60066
MERCEDES						
MBZ0015	GRAPAR	DEP.ENT/SUP:MB:1726/1729/	681	91	BEHR	60052
MBZ0016	GRAPAR	DEP.SAL/INF:MB:1726/1729/	681	91	BEHR	60052
MBZ0017	GRAPAR	DEP.ENT/SUP:NG-90	645	77	BEHR	60066
MBZ0018	GRAPAR	DEP.SAL/INF:NG-90	645	77	BEHR	60066
MBZ0019	GRAPAR	DEP.ENT/SUP:MB: ACTROS	841	77	BEHR	60197
MBZ0020	GRAPAR	DEP.SAL/INF:MB: ACTROS	841	77	BEHR	60197
MBZ0021	GRAPAR	DEP.SUP. MB.ECONIC	690	77	L.R.	60216
MBZ0022	GRAPAR	DEP.INF. MB.ECONIC	690	77	L.R.	60216
MBZ0023	GRAPAR	DEP.SUP. MB. AXOR	701	78		
NISSAN (CARRETILLAS)						
NIS0001	GRAPAR	DEP.CARRET. NISSAN:DCHO	450	48		
NIS0002	GRAPAR	DEP.CARRET. NISSAN:IZDO (SIN ENFR.)	450	48		
NIS5001	SOLDAR	DEP.CARRET. NISSAN:DCHO	450	48		
NIS5002	SOLDAR	DEP.CARRET. NISSAN:IZDO (SIN ENFR.)	450	48		
RVI						
RVI0001	GRAPAR	DEP.SUP.REN.PREMIUN(VALEO)	747	70	VALEO	60187
RVI0002	GRAPAR	DEP.INF.REN.PREMIUN(VALEO)	747	70	VALEO	60187
RVI0003	GRAPAR	DEP.SUP.REN.PREMIUN(BEHR)	732	71	BEHR	60169
RVI0004	GRAPAR	DEP.INF.REN.PREMIUN(BEHR)	732	71	BEHR	60169
RVI0005	GRAPAR	DEP.SUP.REN.PREMIUN(BEHR)	732	71	BEHR	60169
RVI0006	GRAPAR	DEP.RVI MIDLINER SUP	596	72	ND MARSTON	60413
RVI0007	GRAPAR	DEP.RVI MIDLINER INF	596	72	ND MARSTON	60413

REFERENCIA	TIPO	DESCRIPCION	L	A	OE	JUNTA
RVI0010	GRAPAR	DEP.SUP.PREMIUM 05>	732	71	BEHR	60169
RVI0011	GRAPAR	DEP.INF.RVI/MAN BUS	732	71	BEHR	60169
RVI0012	GRAPAR	DEP.INF.PREMIUM 05>	732	71	BEHR	60169
RVI0013	GRAPAR	DEP.INF.PREMIUM 05>	732	71	BEHR	60169
RVI5001	SOLDAR	DEP.RENAULT (V.I.) -LATON	749	70		
SCANIA						
SCA0001	GRAPAR	DEP.ENT/SUP.SCANIA 94-114	718	72	SCANIA	60174
SCA0003	GRAPAR	DEP.ENT/SUP.SCANIA R/T 94	964	72	BEHR	60214
TOYOTA (CARRETILLAS)						
TOY5001	SOLDAR	DEP.CARRETILLA TOYOTA	456	69		
TOY5002	SOLDAR	DEP.CARRETILLA TOYOTA	456	69		
TOY5003	SOLDAR	DEP.CARRETILLA TOYOTA	445	85		
TOY5004	SOLDAR	DEP.CARRETILLA TOYOTA	445	85		
TOY5005	SOLDAR	DEP.CARRETILLA TOYOTA	445	85		
TOY5006	SOLDAR	DEP.CARRETILLA TOYOTA	445	85		
TOY5007	SOLDAR	DEP.CARRETILLA TOYOTA	445	85		
TOY5008	SOLDAR	DEP.CARRETILLA TOYOTA	456	69		
VOLVO						
VOL0006	GRAPAR	DEP.ENT/SUP.:VOLVO:FH-12:	752	81	BLACKSTONE	60168
VOL0007	GRAPAR	DEP.SAL/INF.:VOLVO:FH-12:	752	81	BLACKSTONE	60168
VOL0008	GRAPAR	DEP.ENT/SUP.:VOLVO:FH-16:	909	81	BLACKSTONE	60163
VOL0009	GRAPAR	DEP.SAL/INF.:VOLVO:FH-16:	909	81	BLACKSTONE	60163
VOL0010	GRAPAR	DEP.ENT/SUP.:VOLVO:BUS	578	70	VALEO	60397
VOL0011	GRAPAR	DEP.SAL/INF.:VOLVO:BUS	578	70	VALEO	60397

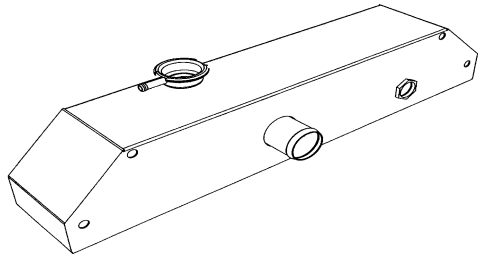
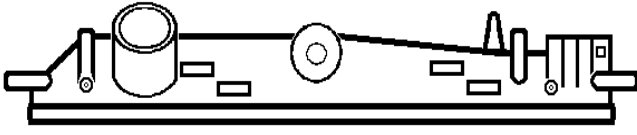
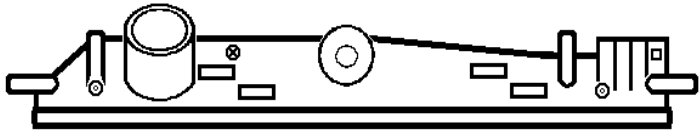
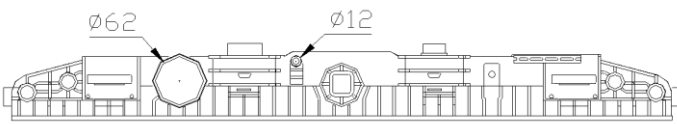
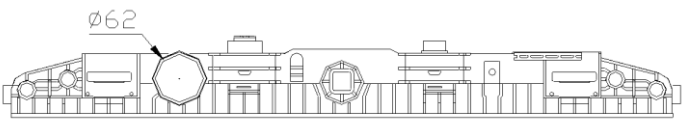
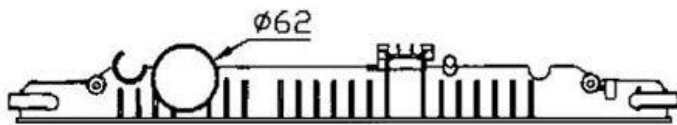
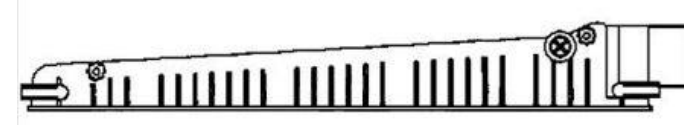
	CAS5005
	
CAS5006	CAT9000
	
DAF0001	DAF0002
	

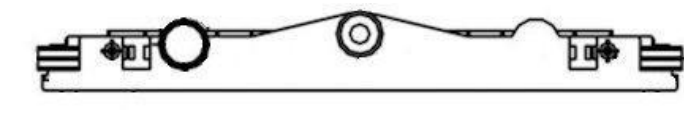
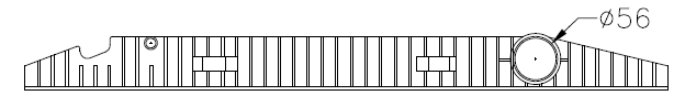
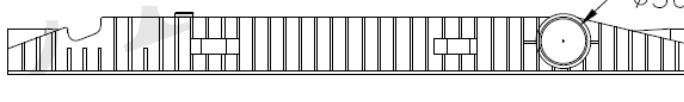
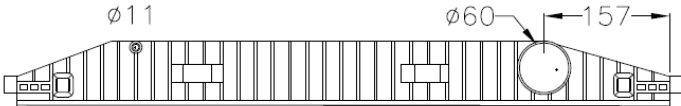
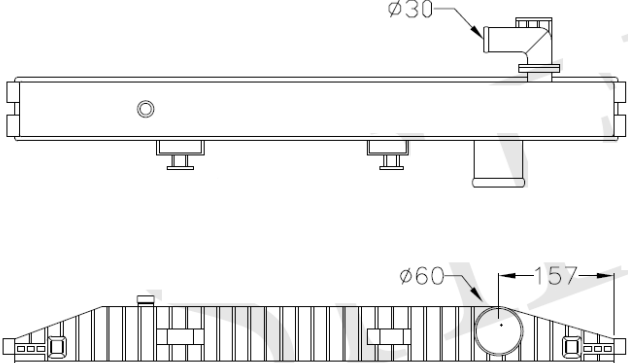
DAF0003	DAF0004
	
DAF0005	DAF0006
	
DAF0007	DAF0008
	
IVE0001	IVE0002
	

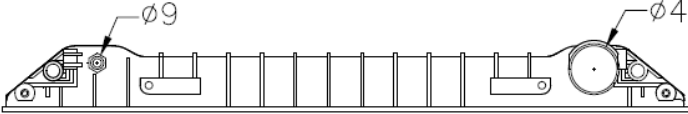
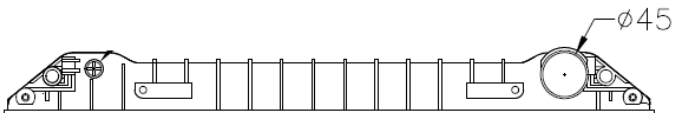
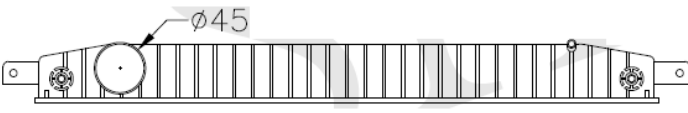
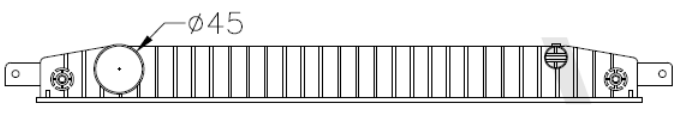
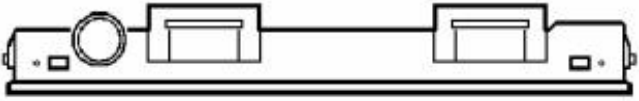
IVE0003	IVE0004
	
IVE0005	IVE0006
	
IVE0007	IVE0008
	
IVE0009	MAN0001
	

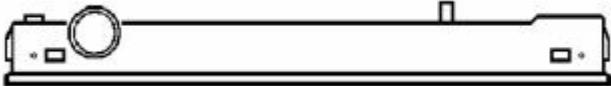
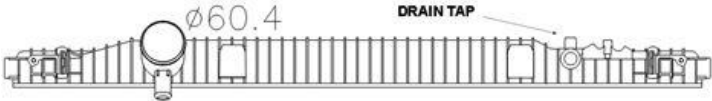
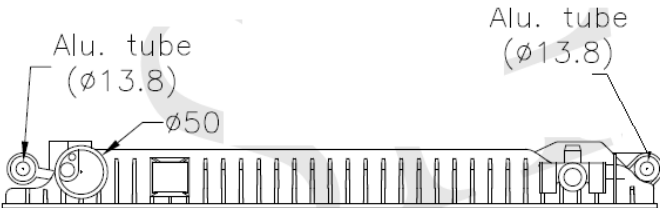
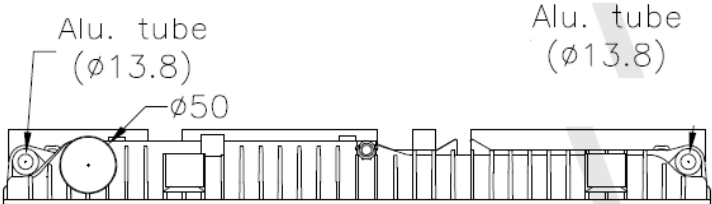
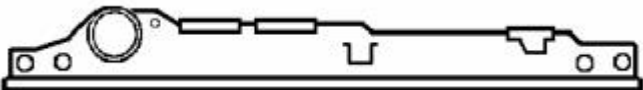
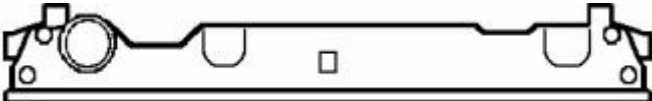
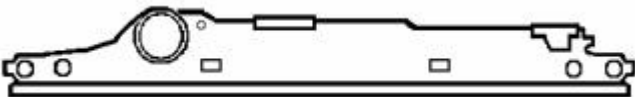
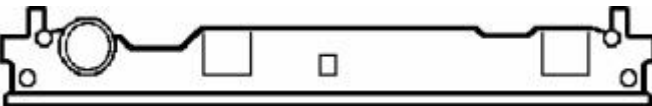
MAN0002	MAN0003
	
MAN0004	MAN0005
	
MBZ0015	MBZ0016
	
MBZ0017	MBZ0018
	

MBZ0019

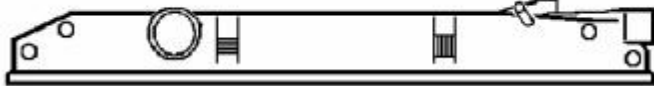

MBZ0020



MBZ0021

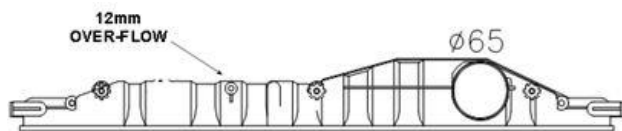

MBZ0022



NI55001

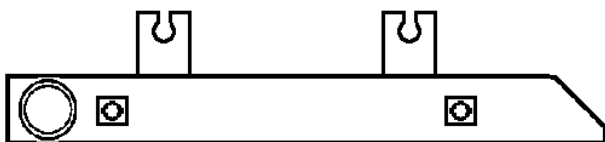

NI55002

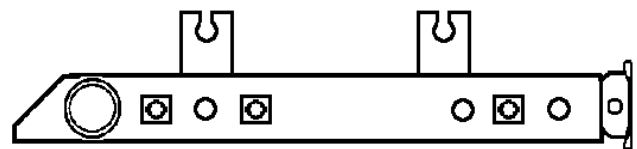











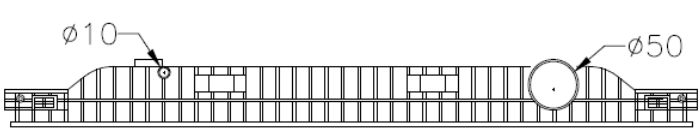

RVI0001





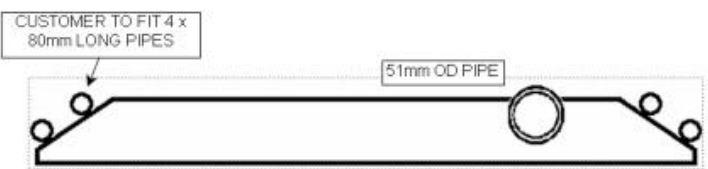

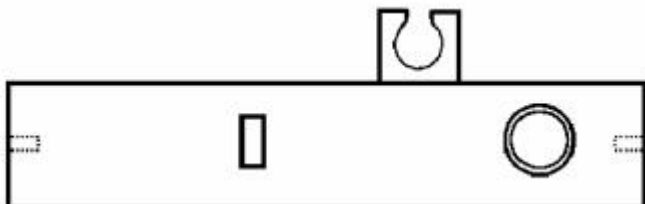
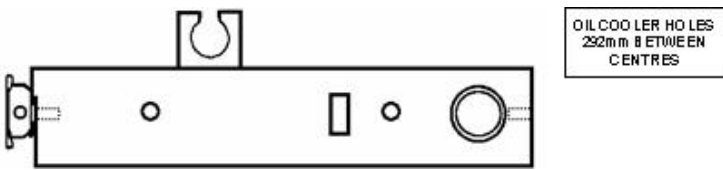
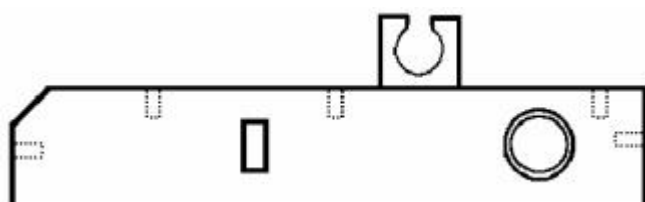

RVI0002

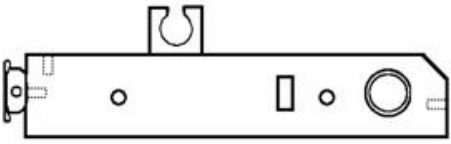
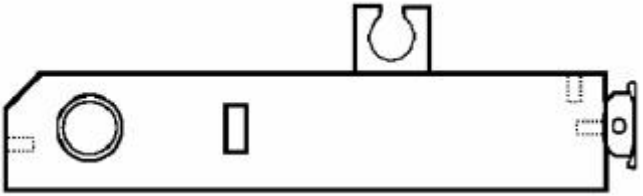
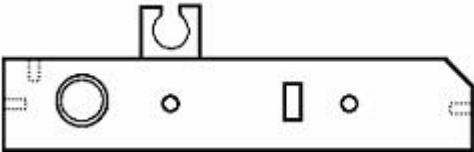
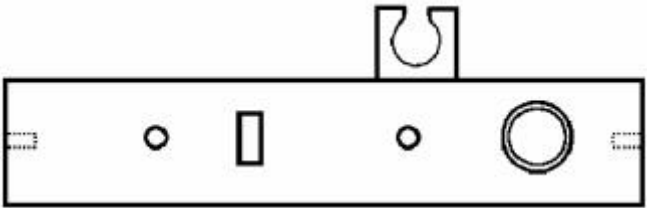

<p>RVI0003</p>	<p>RVI0004</p>
 <p>10mm OVERFLOW</p>	 <p>DRAIN TAP</p> <p>Ø50</p>
<p>RVI0005</p>	<p>RVI0006</p>
 <p>10mm OVERFLOW</p>	 <p>Ø9</p> <p>Ø50</p>
<p>RVI0007</p>	<p>RVI0010</p>
 <p>Ø50</p>	 <p>Ø10</p> <p>Ø50</p>
<p>RVI0011</p>	<p>RVI0012</p>
 <p>(M8*1.25)</p> <p>Ø50</p> <p>(M8*1.25)</p>	 <p>Ø50</p> <p>(M8*1.25)</p>

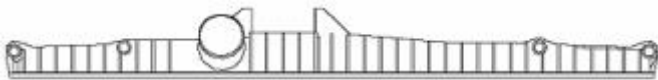
RVI0013	RVI5001
	
SC0001	SCA0003
	
TOY5001	TOY5002
	
TOY5003	TOY5004
	

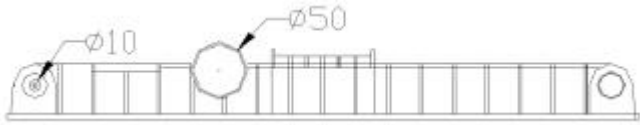
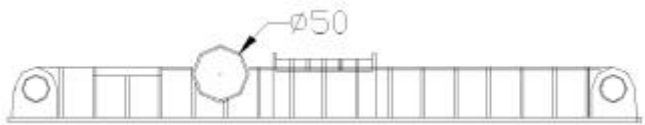
<p>TOY5005</p>	<p>TOY5006</p>
 <p>OIL COOLER HOLES 292mm BETWEEN CENTRES</p>	
<p>TOY5007</p>	<p>TOY5008</p>
 <p>OIL COOLER HOLES 200mm BETWEEN CENTRES</p>	
<p>VOL0006</p>	<p>VOL0007</p>
 <p>BRASS TANK AVAILABLE REF: VOL9000</p>	 <p>BRASS TANK AVAILABLE REF: VOL9001</p>
<p>VOL0008</p>	<p>VOL0009</p>
 <p>BRASS TANK AVAILABLE REF: VOL9002</p>	 <p>BRASS TANK AVAILABLE REF: VOL9003</p>

VOL0010	VOL0011
	
VOL9002	
	

ANOTACIONES
